

MCX/MMBX series

R113-R213 / R223

SP
W
W
W
SP

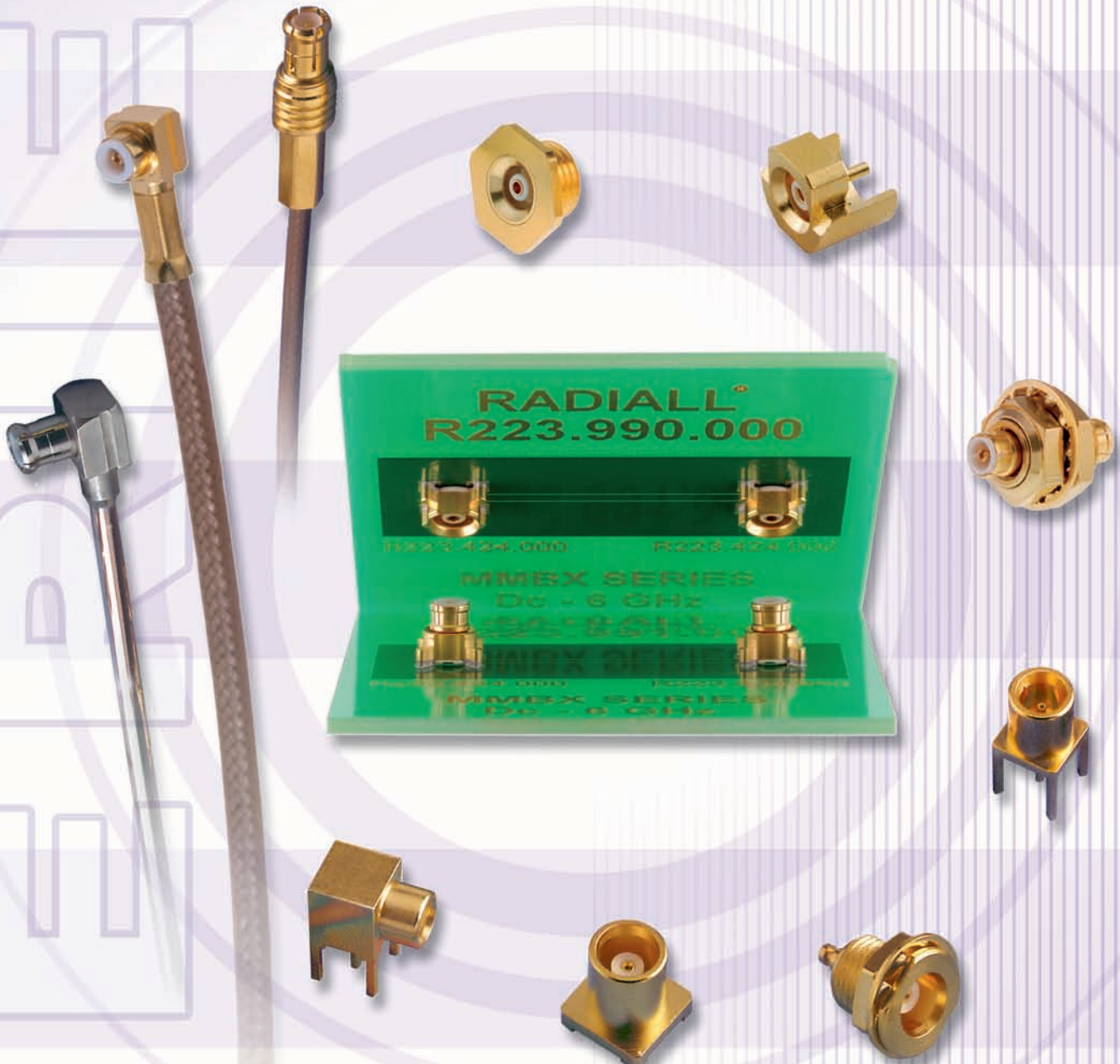

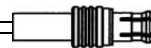

	PAGE
MCX	
General	4
Interface.....	5
Characteristics	6
Straight plugs	7
Right angle plugs	8
Straight jacks	9
Straight bulkhead jacks	10
Receptacles.....	11-12
Receptacles and in series adapters	13
Panel drillings	14
Assembly instructions	15-23
MMBX	
Introduction.....	25-26
General.....	27
Interface.....	28
Characteristics.....	29
Plugs.....	30
Plugs and receptacles	31
PCB receptacles.....	32
Receptacles and adapters.....	33
Adapters	34
Panel drilling and receptacles packaging	35
Assembly instructions	36-41

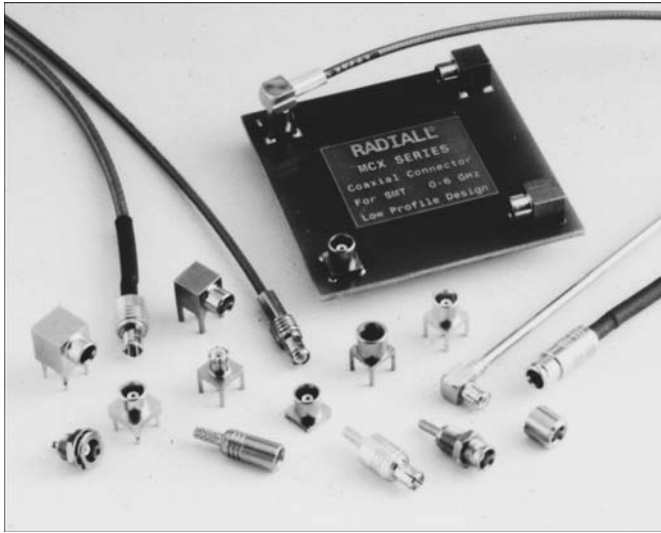

50 Ω	DC - 6 GHz
75 Ω	

INTRODUCTION

- Subminiature coaxial connectors
- "Push-pull" snap-on mating
- Complies with specification CECC 22220
- CEI standard 1169-36

APPLICATIONS

50 Ω models

- Wireless communications
- Civil and military radio-telecommunication equipment

75 Ω models

- Videocommunication
- Television broad casting

The **MCX series** utilizes the SMB series electrical line and features a particularly simple, compact and robust interface.

The MCX series is 30 % smaller than the SMB.

The **MCX series** helps to **miniaturize equipment**. It lowers wiring connection costs through its full crimp and solder-crimp versions as the centre contact of the straight models can be either crimped or soldered. It optimizes PCB layouts with its range of models for PCBs including surface mount and press-fit receptacles.

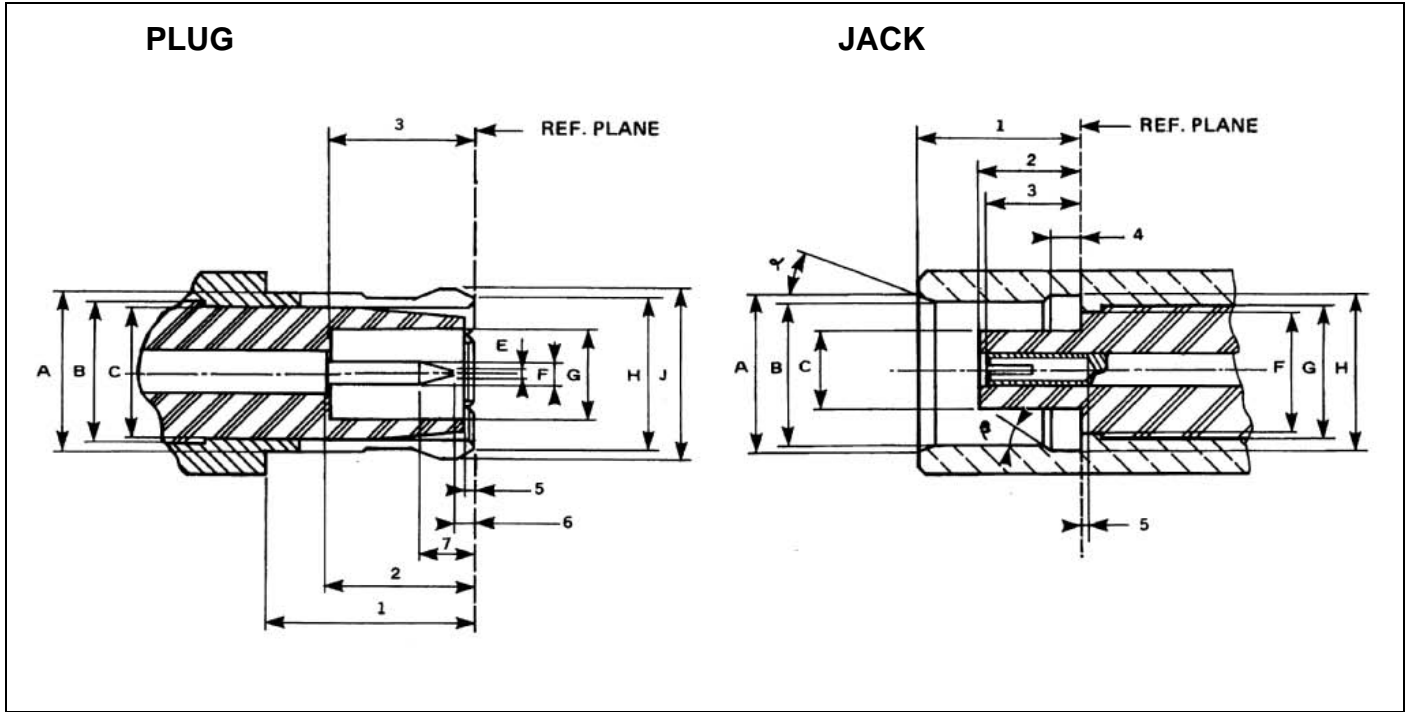
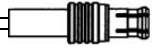

ITEM	mm		inch	
	min.	max.	min.	max.
1	4.15	-	.163	
2	2.80	3.20	.110	.126
3	2.80		.110	
5	0	0.30	0	.012
6	0.15		.006	
7		1.20		.047
A		3.40		.134
B	3.05 NOM.		.120 NOM.	
C		3.00		.118
E		0.25		.010
F	0.48	0.53	.019	.021
G	2.00		.079	
H		3.60		.142
J		3.80		.150

ITEM	mm		inch	
	min.	max.	min.	max.
1	4.00	4.12	.157	.162
2	2.60	2.80	.102	.110
3	2.30	2.80	.090	.110
4	0.75	0.85	.029	.033
5	0		0	
α	18°	22°	18°	22°
β	43°	47°	43°	47°
A	3.80		.150	
B	3.42	3.48	.135	.137
C		1.98		.078
F		3.00		.118
G	3.05 NOM.		3.05 NOM	
H	3.60	3.75	.142	.148



REQUIREMENT	GENERAL SPECIFICATIONS		
-------------	------------------------	--	--

ELECTRICAL

Impedance	50 Ω and 75 Ω		
Frequency range	DC - 6 GHz		
Typical V.S.W.R.	1 GHz	2.5 GHz	6 GHz
• <i>Straight styles</i> .085 2.6/50/S	1.04 1.06	1.08 1.09	1.13 1.12
• <i>Right angle styles</i> .085 2.6/50/S	1.03 1.04	1.06 1.07	1.10 1.10
Insulation resistance	1 000 MΩ		
Contact resistance (mΩ)	Initial	After environment	
• <i>centre contact</i> • <i>outer contact</i>	≤ 5 ≤ 2.5	≤ 15 ≤ 7.5	
Voltage rating (V.R.M.S.)	At sea level	At 70.000 Ft	
• <i>Cable RG 196/U - RG 188A/U - .047"</i> • <i>∅ 2.6 double screen</i> • <i>RG 405/U - .085</i>	170 V rms max 335 V rms max 250 V rms max	45 V rms max 85 V rms max 65 V rms max	
Dielectric withstanding voltage	At sea level	At 70.000 Ft	
• <i>Cable RG 196/U - RG 188A/U - .047"</i> • <i>∅ 2.6 double screen</i> • <i>RG 405/U - .085</i>	500 V rms max 750 V rms max 750 V rms max	100 V rms max 100 V rms max 100 V rms max	
Power	P = 120W at 1.8 GHz, T = 40°C at sea level, VSWR = 1.1 for a straight plug MCX for ∅ 2.6/50/D cable		

MECHANICAL

Mechanical endurance	500 matings	
Engagement and separation force	<i>Engagement</i> ≤ 14.2 lbs - 63 N max	<i>Separation</i> ≥ 1.8 Lbs-8N ≤ 4.5 lbs 20 N
Cable retention force	<i>RG 196A/U-</i> <i>RG 188A/U-</i> <i>∅ 2.6/50 Ω double screen</i> <i>.047"</i> <i>RG 405/U-.085</i>	≥ 7.2 lbs - 32 N ≥ 11.9 lbs - 53 N ≥ 24.1 lbs - 107 N ≥ 9.7 lbs - 43 N ≥ 34.9 lbs - 155 N
Contact captivation	Axial force 2.25 Lbs 10 N	

ENVIRONMENTAL

Operating temperature	-55°C +155°C	
Temperature cycling	CECC 22220 paragraph 4-6-5	
Thermal shock	CECC 22220 paragraph 4-6-7	MIL STD 202 - method 107 condition C
High temperature test	CECC 22220 paragraph 4-7-2	MIL STD 202 - method 108A condition D
Corrosion (salt spray)	CECC 22220 paragraph 4-6-10	MIL STD 202 - method 101 condition B
Vibration	CECC 22220 paragraph 4-6-3	MIL STD 202 - method 204 condition D

MATERIALS

Bodies and male contacts	Brass
Interface and female centre contacts	Beryllium copper
Ferrules	Brass
Insulators	PTFE

PLATING

Bodies	Gold / BBR*
Centre contacts	Gold

* BBR Bright Bronze Radial

Standard packaging = 100 pieces. For unit packaging add «W» after the P/N

All dimensions are given in mm

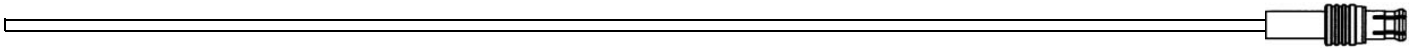

STRAIGHT PLUGS, FULL CRIMP TYPE, FOR FLEXIBLE CABLE

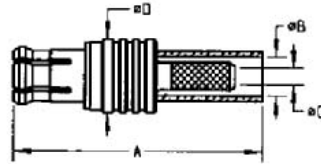
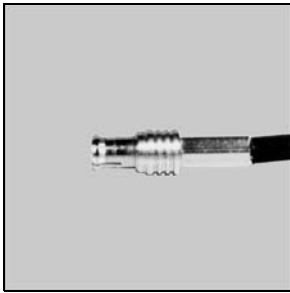

Cable group	Part number	Imp. (Ω)	Dimensions (mm)				Captive center contact	Assembly instructions	Finish
			A	B	C	D			
2 / 50 / S	R113 081 000	50	16	2.55	1.1	5	no	Gold	
	R113 081 020							BBR	
2.6 / 50 / S	R113 082 000			2.95	1.65			yes	Gold
	R113 082 020								BBR
2.6 / 50 / D	R113 083 000			3.25	1.7		Gold		
	R113 083 020						BBR		
2.6 / 75 / S	R213 082 007			18.2	2.95		1.7	5.8	BBR
2.6 / 75 / D	R213 083 007			18.3	3.25				

STRAIGHT PLUGS, SOLDER TYPE, FOR SEMI-RIGID CABLE

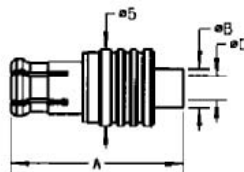
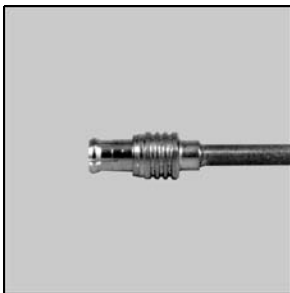

Cable group	Part number	Imp. (Ω)	Dimensions (mm)			Captive center contact	Assembly instructions	Finish
			A	B	C			
.047"	R113 051 000•	50	11.3	2	1.3	no	M 04	Gold
	R113 051 020•							BBR
.085"	R113 053 000			3	2.25			Gold
	R113 053 020•							BBR

• Upon request

RIGHT ANGLE PLUGS, CRIMP TYPE, FOR FLEXIBLE CABLE (captive center contact)

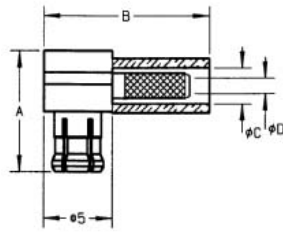
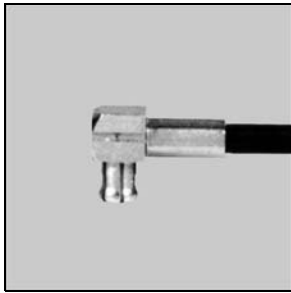

Fig. 1

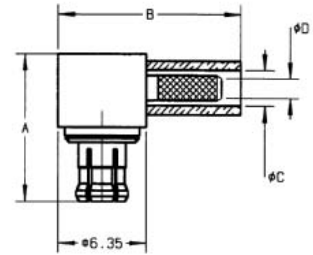
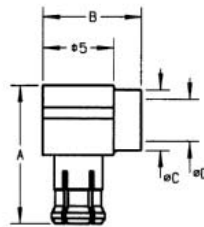
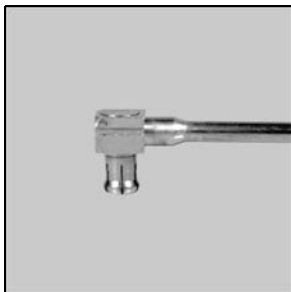

Fig. 2

Cable group	Part number	Fig.	Imp. (Ω)	Dimensions (mm)				Assembly instructions	Finish
				A	B	C	D		
2 / 50 / S	R113 181 000	1	50	8.6	11.9	2.55	1.1	M 05	Gold
	R113 181 020								BBR
2.6 / 50 / S	R113 182 000					2.95	1.65		Gold
	R113 182 020								BBR
2.6 / 50 / D	R113 183 000					3.25	1.7		Gold
	R113 183 020								BBR
2.6 / 75 / S	R213 182 007	2	75	10.6	13.3	2.95	1.7	M 05	BBR
2.6 / 75 / D	R213 183 007								3.25

RIGHT ANGLE PLUGS, SOLDER TYPE, FOR SEMI-RIGID CABLE (captive center contact)



Cable group	Part number	Imp. (Ω)	Dimensions (mm)				Assembly instructions	Finish
			A	B	C	D		
.047"	R113 151 000	50	8.5	7	2	1.3	M 03	Gold
	R113 151 020•							BBR
.085"	R113 153 000		3	2.25	2.35	M 02	Gold	
	R113 153 020•						BBR	
2 / 50	R113 161 000		7.9	8	3	2.35	M 02	Gold
2.6 / 50	R113 161 020							BBR
.085"	R113 155 000	9.3	7	4.35	3.05	M 03	Gold	
.141"								

• Upon request

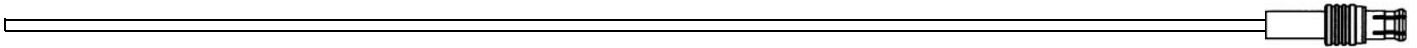

STRAIGHT JACKS, FULL CRIMP TYPE, FOR FLEXIBLE CABLE

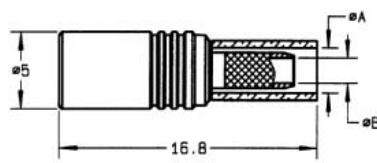
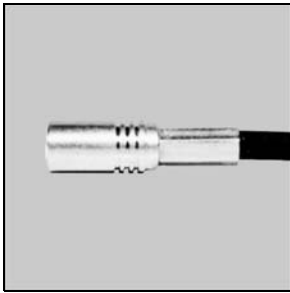

Fig. 1

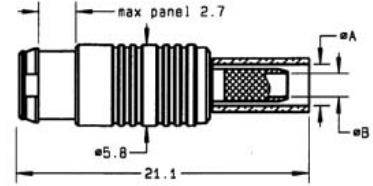
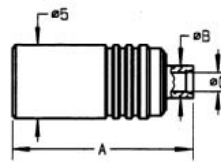
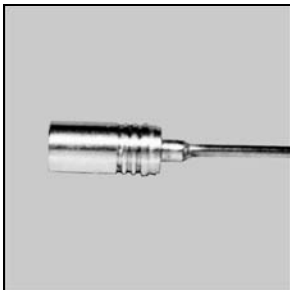

Fig. 2

Cable group	Part number	Fig.	Imp. (Ω)	Dimensions (mm)		Captive center contact	Panel drilling	Assembly instructions	Finish (note)
				A	B				
2 / 50 / S	R113 236 000	1	50	2.55	1.1	no		M 01	Gold
	R113 236 020				BBR				
2.6 / 50 / S	R113 240 000			2.95	1.65	yes			Gold
2.6 / 50 / D	R113 241 000• R113 241 020•			3.25					BBR
2.6 / 75 / S	R213 238 007	2	75	2.95	1.7	yes	P 01	M 01	BBR (Snap mount Panel thickness 2.5 ⁰ _{-0.1})
2.6 / 75 / D	R213 239 007			3.25					

STRAIGHT JACKS, SOLDER TYPE, FOR SEMI-RIGID CABLE



Cable group	Part number	Imp. (Ω)	Dimensions (mm)			Captive center contact	Assembly instructions	Finish		
			A	B	C					
.047"	R113 221 000• R113 221 020•	50	11.9	2	1.3	no	M 04	Gold		
					BBR					
.085"	R113 223 000 R113 223 020•							3	2.25	Gold
										BBR

• Upon request

STRAIGHT BULKHEAD JACKS, FULL CRIMP TYPE, FOR FLEXIBLE CABLE

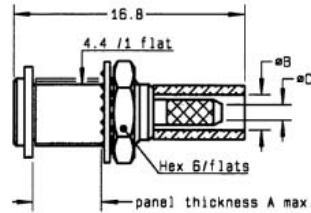
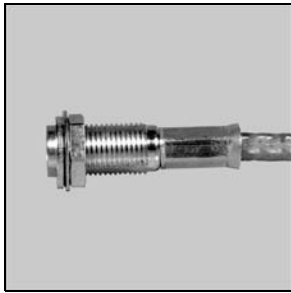

Fig. 1

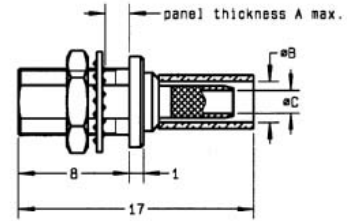
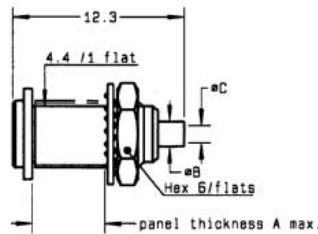
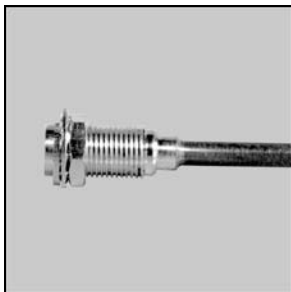

Fig. 2

Cable group	Part number	Fig.	Imp. (Ω)	Dimensions (mm)			Captive center contact	Assembly instructions	Panel drilling	Finish	Note
				A	B	C					
2 / 50 / S	R113 306 000	1	50	5	2.55	1.1	no	M 01	P 02	Gold	
	R113 306 020					BBR					
2.6 / 50 / S	R113 310 000	2	50	5	2.95	1.65	yes	M 01	P 02	Gold	Rear mount
	R113 310 020•										
2.6 / 50 / D	R113 312 000•	1	50	5	3.25	1.65	yes	M 01	P 02	Gold	Rear mount
	R113 311 000										
2.6 / 50 / D	R113 311 020•	1	50	5	3.25	1.65	yes	M 01	P 02	Gold	Rear mount
	R113 311 020•										

STRAIGHT BULKHEAD JACKS, SOLDER TYPE, FOR SEMI-RIGID CABLE



Cable group	Part number	Imp. (Ω)	Dimensions (mm)			Captive center contact	Assembly instructions	Panel drilling	Finish
			A	B	C				
.047"	R113 301 000•	50	5	2	1.3	no	M 04	P 02	Gold
	R113 301 020•								BBR
.085"	R113 303 000	50	2.6	3	2.25	no	M 04	P 02	Gold
	R113 303 020•								Nickel

• Upon request

STRAIGHT FEMALE PANEL RECEPTACLES (captive center contact)

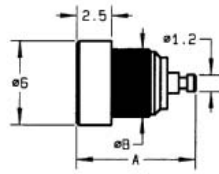
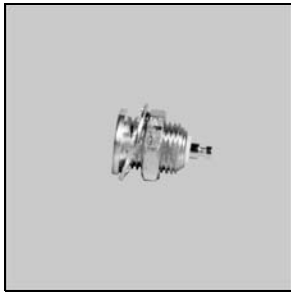

Fig. 1

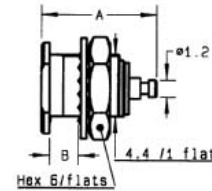

Fig. 2

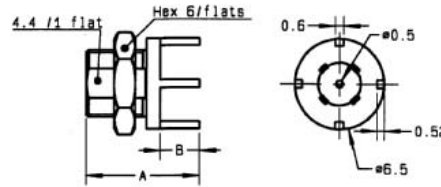
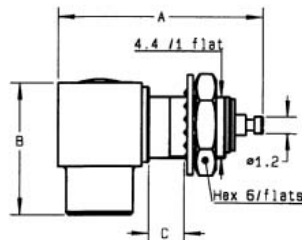

Fig. 3

Part number	Fig.	Imp. (Ω)	Dimensions (mm)		Panel drilling	Finish	Note
			A	B			
R113 402 220•	1	50	8.7	4.8	P 03	BBR	Press-in mount
R113 553 000	2		8.65	2.5	P 02	Gold	Recessed front mount
R113 553 020			BBR				
R113 554 020•	3		7.8	2.8	P 04	BBR	Panel mount + PCB

RIGHT ANGLE FEMALE PANEL RECEPTACLES (captive center contact)



Part number	Imp. (Ω)	Dimensions (mm)			Panel drilling	Finish
		A	B	C		
R113 670 000•	50	14.1	9.4	2.5	P 02	Gold
R113 670 020•						BBR

• Upon request

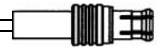

STRAIGHT FEMALE PCB RECEPTACLES (captive center contact)

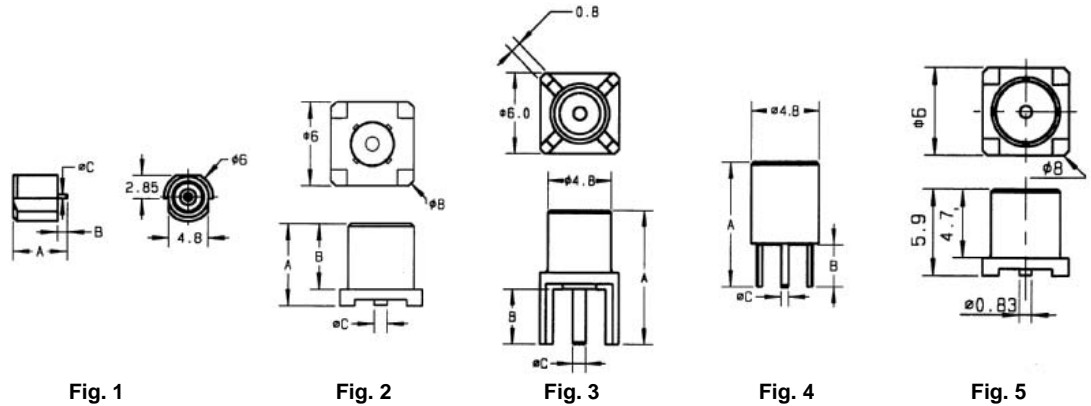
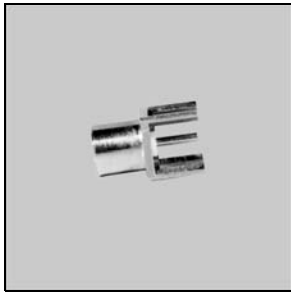

Part number	Fig.	Imp. (Ω)	Dimensions (mm)			Assembly instructions	Panel drilling	Finish	Note				
			A	B	C								
R113 423 000	1	50	6.9	1.4	0.5	M 07		Gold	SMT / Edge-card				
R113 423 810									SMT / reel 500 pieces				
R113 423 820									SMT / reel 100 pieces				
R113 424 000	2		5.9	4.7	0.96							SMT	
R113 424 010												SMT / reel 100 pieces	
R113 424 020												SMT / reel 500 pieces	
R113 426 000	3		75	10	4				0.98	P 05			Short pins
R113 426 010•					3.6								
R113 426 020					4								
R113 427 000	4			9	3				0.5		P 06		Gold
R113 427 020•		BBR											
R213 426 000•	3	75		10	4.1	0.71		P 05	Gold				
R213 424 800	5										M 07		SMT / reel 100 pieces

STRAIGHT MALE PCB RECEPTACLES (captive center contact)

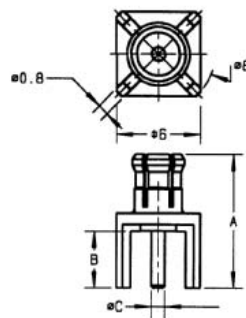
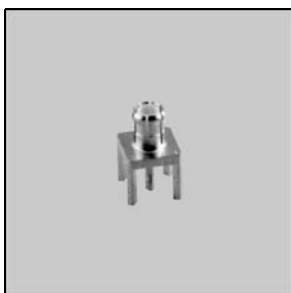

Part number	Imp. (Ω)	Dimensions (mm)			Panel drilling	Finish
		A	B	C		
R113 425 000•	50	9.6	4	0.96	P 05	Gold

• Upon request

RIGHT ANGLE FEMALE PCB RECEPTACLES (captive center contact)

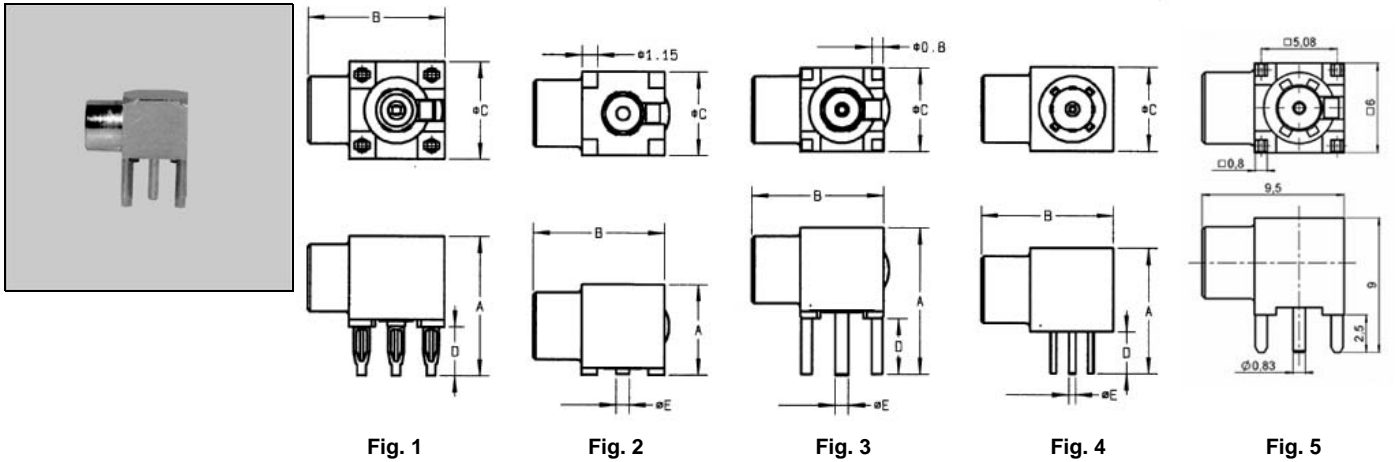

Part number	Fig.	Imp.(Ω)	Dimensions (mm)					Assembly instructions	Panel drilling	Finish	Note			
			A	B	C	D	E							
R113 661 000	1	50	10	10	7	3.5	0.96	M 06	P 04	Gold	Press-fit PCB mount			
R113 661 027										BBR				
R113 664 000	2		6.5	9.5	6	4		0.96	M 07		Gold	SMT		
R113 664 100												SMT / reel 100 pieces		
R113 664 120												SMT / reel 500 pieces		
R113 665 000	3		75	10.5	9.5	6		4	0.83	M 07	P 05	BBR		
R113 665 020														
R113 665 147	4			9	9.4	3		2.5		0.5	M 07	P 06	Gold	Space saving pattern
R113 666 020													BBR	
R213 664 800•	2			75	6.5	9.5		6		4	0.83	M 07	P 05	Gold
R213 665 000	3	10.5												
R213 665 120	5	9			2.5									

IN SERIES ADAPTERS (FEMALE - FEMALE)

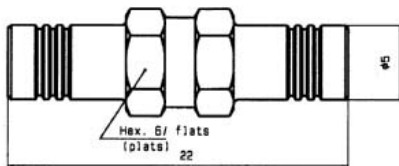

Part number	Imp.(Ω)	Finish
R113 704 000	50	Gold
R113 704 020		BBR

• Upon request

PANEL DRILLING

P01

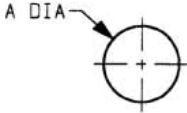

	MM		INCH	
	maxi	mini	maxi	mini
A	5	4.97	0.197	0.196

P02

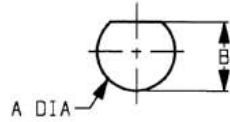

	MM		INCH	
	maxi	mini	maxi	mini
A	5	4.9	0.197	0.19
B	4.58	4.46	0.18	0.176

P03

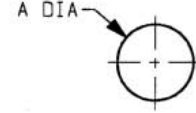

	MM		INCH	
	maxi	mini	maxi	mini
A	4.77	4.74	0.188	0.187

P04

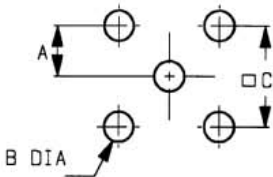

	MM		INCH	
	maxi	mini	maxi	mini
A	2.565	2.515	0.101	0.1
B	1.09	0.94	0.043	0.037
C	5.105	5.055	0.201	0.199

P05

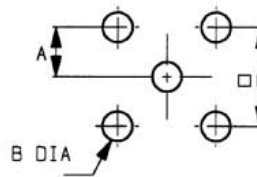

	MM		INCH	
	maxi	mini	maxi	mini
A	2.56	2.52	0.101	0.099
B	1.4	1.3	0.055	0.051
C	5.13	5.03	0.202	0.198

P06

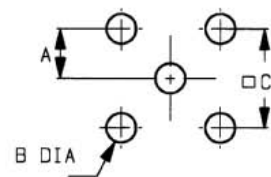

	MM		INCH	
	maxi	mini	maxi	mini
A	1.30	1.24	.051	.049
B	0.89	0.79	.035	.031
C	2.59	2.49	.102	.098

P07

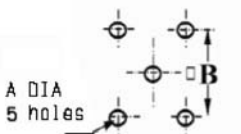

	MM		INCH	
	maxi	mini	maxi	mini
A	1.4	1.3	0.055	0.051
B	5.13	5.03	0.202	0.198

PACKAGING

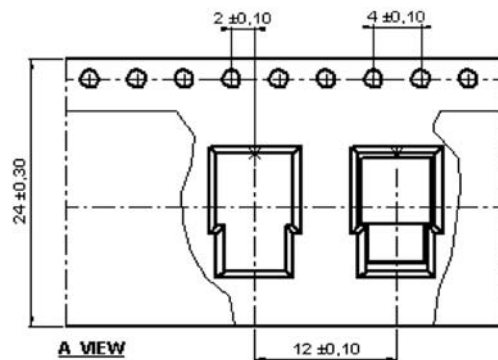
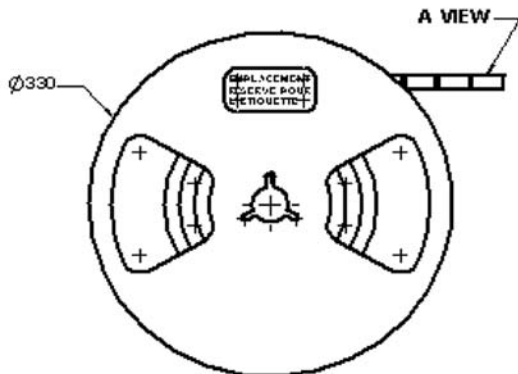

M 01

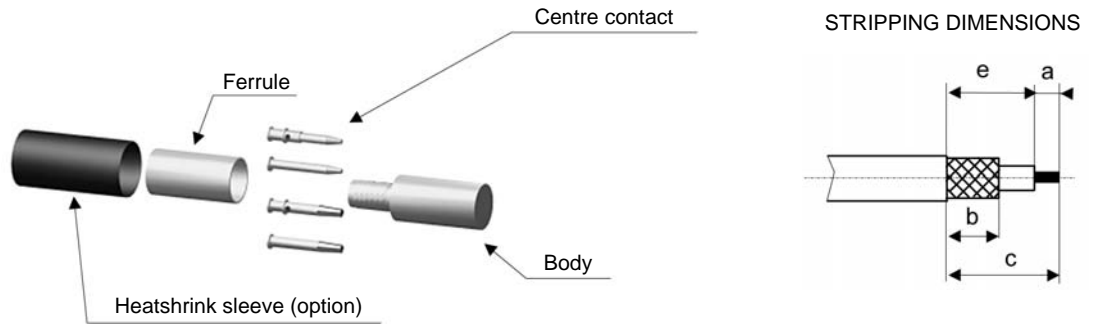

Part number			Stripping dimensions (mm)				Center contact crimping tool	Ferrule crimping tool	
			a	b	c	e		Dies included	MIL standard R282 293 000 (M22520/5-01) + Dies
R113 081 000	R113 236 000	R113 306 020	2.5	6	10	7,5	R282 271 000 sq 0.72	R282 271 000 Hex 3.25	R282 235 003 Hex 3.25
R113 081 020	R113 236 020	R113 310 000							
R113 082 000	R113 240 000	R113 310 020							
R113 082 020	R113 241 000	R113 311 000							
R113 083 000	R113 241 020	R113 311 020							
R113 083 020	R113 306 000	R113 312 000							
R213 082 007	R213 238 007		2.3	5.5	10.3	8			
R213 083 007	R213 239 007								

- 1**
- Slide the heatshrink sleeve onto the cable (option).
 - Slide the ferrule onto the cable.
 - Strip the cable.

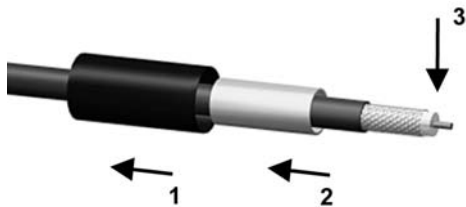

- 2**
- Slide the centre contact on until it bottoms against the cable dielectric.
 - Crimp the centre contact with crimping tool (see table).



- 3**
- Fan the braid.

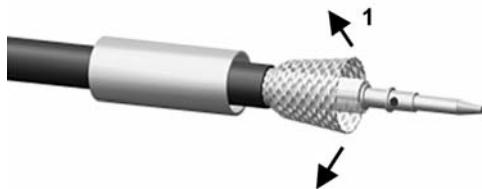

- 4**
- Slide the cable into the body until it bottoms against insulator.

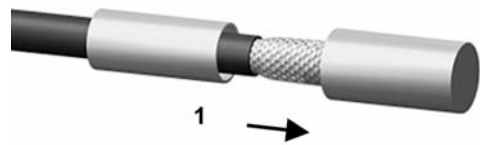

- 5**
- Slide the ferrule over the braid.
 - Crimp the ferrule with crimping tool (see table).

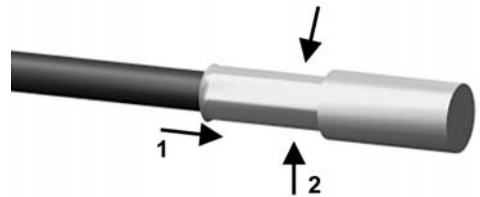

- 6**
- Cut the excess of braid if necessary.
 - Slide the sleeve over the ferrule and heatshrink it in place (option).

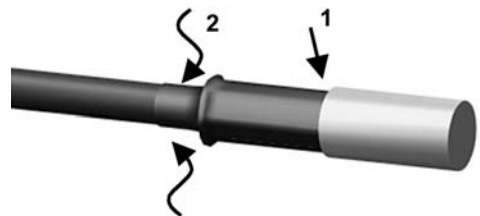

M 02

For cable .085"

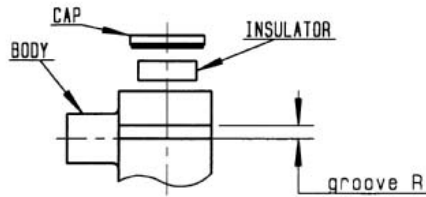

We recommend a thermal preconditioning of the cable

Part number	Mounting tool	Positioner	Assembly jig
R113 161 000 R113 161 020	R282 868 000	R282 864 010	R282 740 020

1

- Strip the cable.
- Clean the cable.
- Tin cable inner conductor.

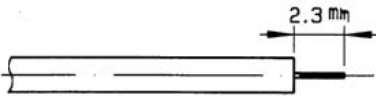

2

- Introduce the positioner and the cable into the connector body until contact with the body shoulder, place the sub assembly into the assembly jig and tighten it.
- Solder body on the cable and let assembly cool down before removing it from the jig.
- Clean soldering area.

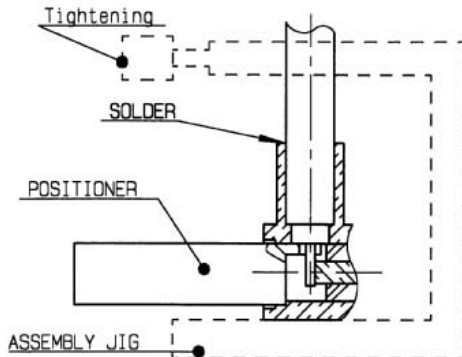

3

- Solder cable inner conductor into the centre contact.
- Clean soldering area.
- Introduce the insulator into the body.
- Press fit the cap.

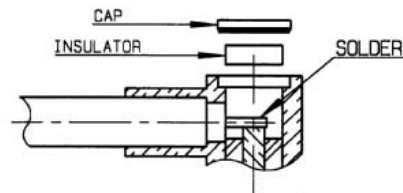

4

- Slide mounting tool onto the body grooves.
- Press fit the cap turning tool handle with adapted wrench .275(AF) (cap in the same plan than square face).

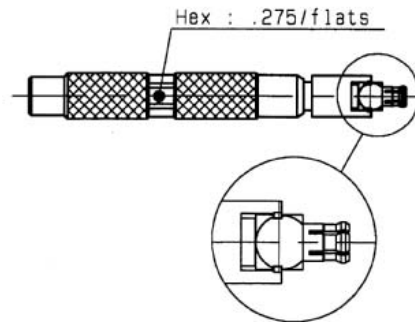

M 02

For cable 2 & 2.6/50

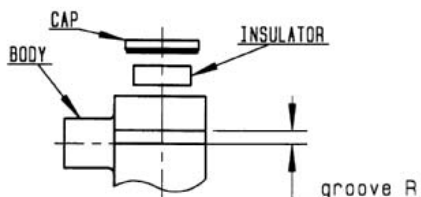

Part number	Mounting tool
R113 161 000	R282 868 000
R113 161 020	

1

- For the 2/50 cable.
- Strip the cable.
- Return the braid.
- Strip the dielectric.
- Tin cable inner conductor.



- For the 2.6/50 cable.
- Strip the cable.
- Tin cable inner conductor.

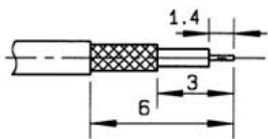

2

- Push the cable into the connector body until contact with it.
- Solder the cable on the connector body.
- Solder cable inner conductor into the centre contact.
- Clean soldering area.

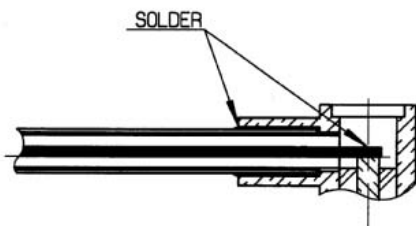

3

- Introduce the insulator into the body.
- Press fit the cap.

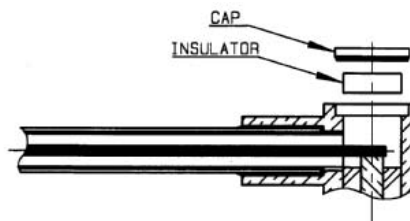

4

- Slide mounting tool onto the body grooves.
- Press fit the cap turning tool handle with adapted wrench .275(AF) (cap in the same plan than square face).

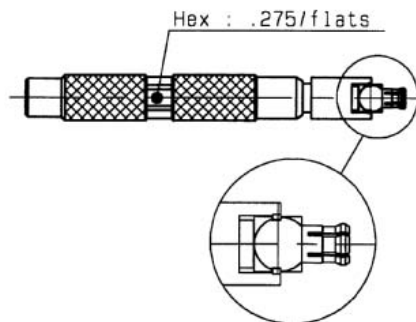

M 03

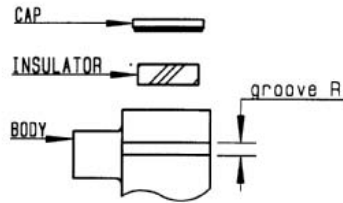

STRIPPING DIMENSIONS

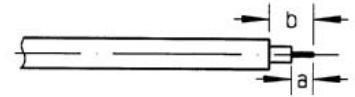

We recommend a thermal preconditioning of the cable

Part number	Stripping length (mm)		Mounting tool	Assembly jig	Crimping instructions	
	a	b			Positioner	For use
R113 151 000 R113 151 020	2.2	3.2	R282 868 000	R282 740 020	R282 864 010	Option 1
R113 153 000 R113 153 020					R282 864 000	
R113 155 000	2.7					Option 2

1

- Strip the cable.
- Tin the centre conductor.
- Clean soldering area.

2

OPTION 1

- Introduce the positioner and the cable into the connector body until contact with the body shoulder, place the sub assembly into the assembly jig and tighten it.
- Solder body on the cable and let assembly cool down before removing it from the jig.
- Clean soldering area.

OPTION 2

- Push the cable into the connector body until it bottoms out.
- Solder the body.
- Clean soldering area.

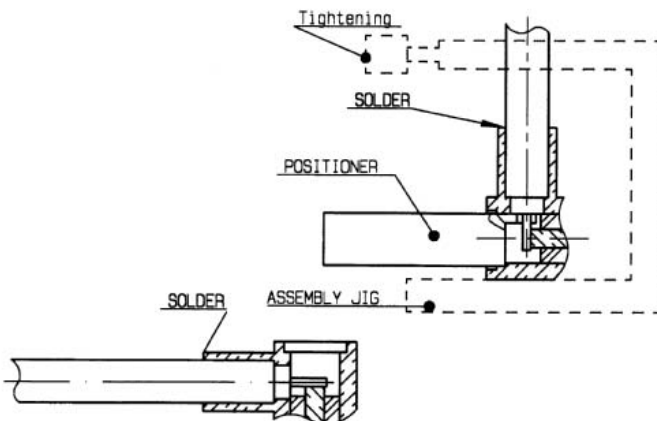

3

- Solder the cable inner conductor.
- Clean solder area.
- Introduce the insulator into the body.
- Place the cap.

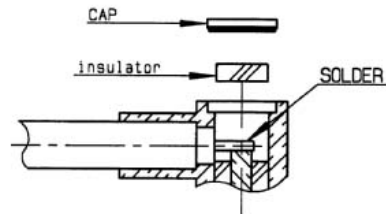

4

OPTION 1

- Slide mounting tool onto the body grooves.
- Press fit the cap turning tool handle with adapted wrench .275(AF) (cap in the same plan than square face).

OPTION 2

- Place the cap.
- Press cap flush or slightly below surface of body assembly.

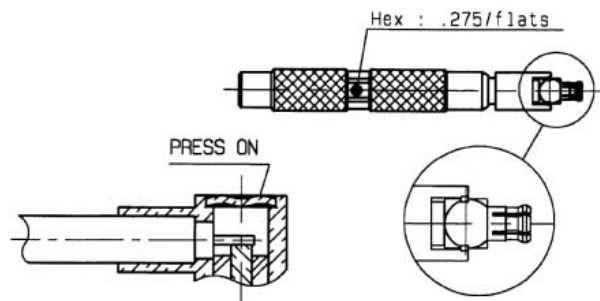

M 04

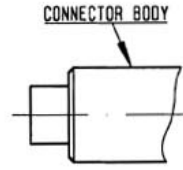
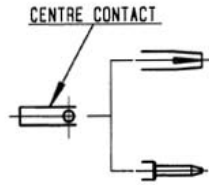

STRIPPING DIMENSIONS

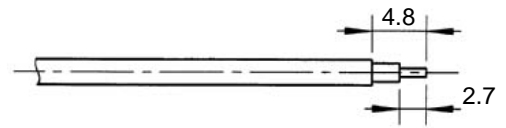

We recommend a thermal preconditioning of the cable

Part number			Assembly jig
R113 051 000	R113 221 000	R113 301 000	R282 740 020
R113 051 020	R113 221 020	R113 301 020	
R113 053 000	R113 223 000	R113 303 000	
R113 053 020	R113 223 020	R113 303 020	

- 1** - Strip the cable.

- 2** - Tin centre contact solder pot.
 - Solder the cable inner conductor into centre contact.
 - Clean solder area.

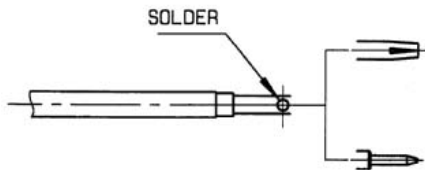

- 3** - Introduce the cable into the connector body until contact with the body shoulder.
 - Place the sub assembly into the assembly jig with positioner MCX male and tighten it.
 - Solder body on the cable.
 Let the assembly cool down before removing it from the jig.
 - Clean solder.

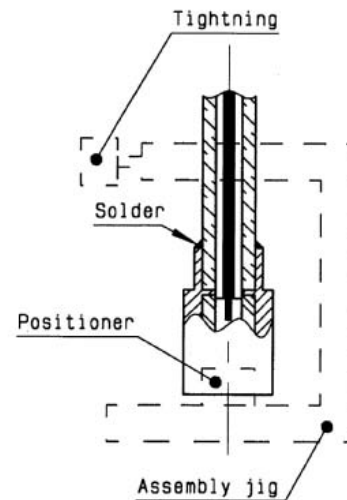

M 05

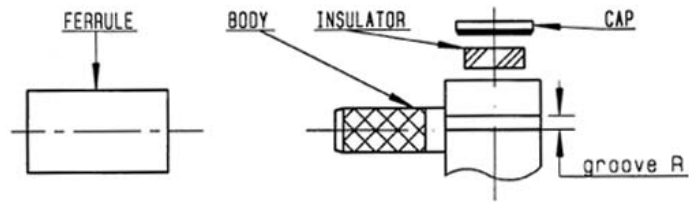

Part number	Stripping length (mm)			Crimping tool		Mounting tool	Operation
	a	b	c	Dies included	MIL standard R282 293 000 (M22520/5-01) + Dies		
R113 181 000 R113 181 020 R113 182 000 R113 182 020 R113 183 000 R113 183 020	2	3	8	R282 271 000	R282 235 003	R282 868 000	Option 1
R213 182 007 R213 183 007	1.7	4.2	9.7				

- 1**
- Slide onto the cable the ferrule.
 - Strip the cable.
 - Tin cable inner conductor.

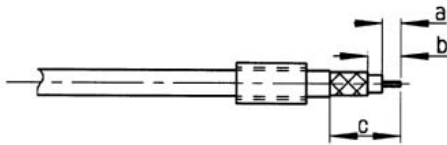

- 2**
- Fan the braid.
 - Push connector body under the braid.
 - Slide the ferrule on the braid (in direction F).

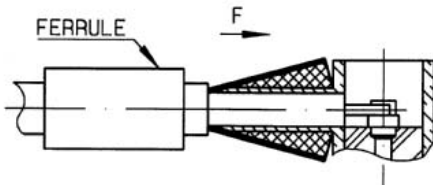

- 3**
- Crimp the ferrule with crimping tool.
 - Solder inner conductor.
 - Introduce the insulator into the body (except for R213 connectors).

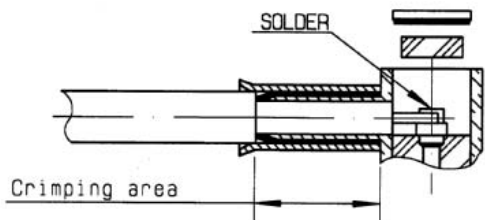

- 4**
- OPTION 1**
- Slide mounting tool onto the body grooves.
 - Press fit the cap turning tool handle with adapted wrench .275(AF) (cap in the same plan than square face).
- OPTION 2**
- Place the cap.
 - Press cap flush or slightly below surface of body assembly.

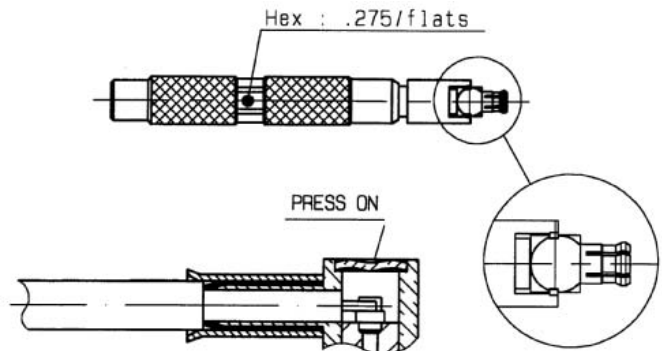

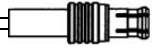

M 06

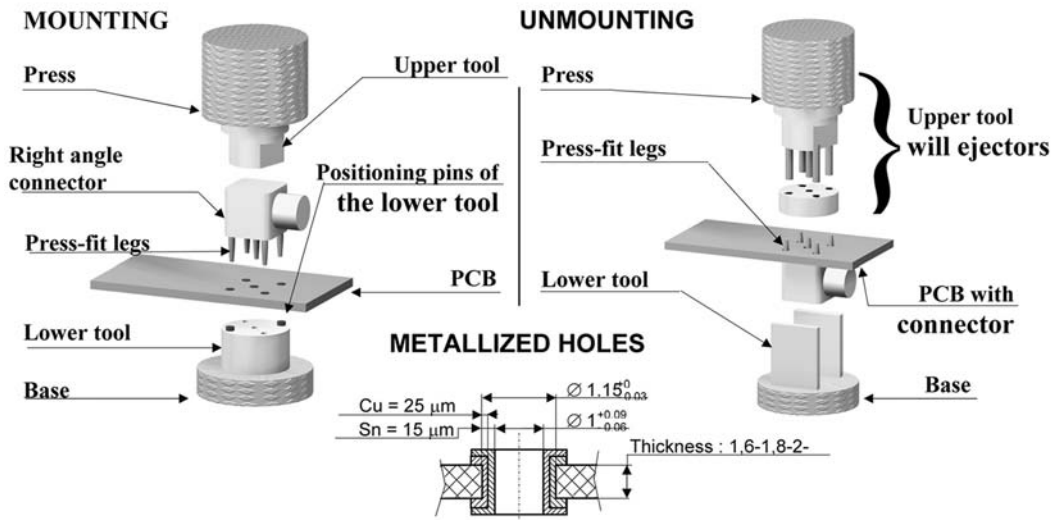

Part number	Mounting tool		Unmounting tool	
	Upper	Lower	Upper	Lower
R113 661 000 R113 661 027	R282 878 500	R282 878 523	R282 878 513	R282 878 533

1

- Slide the upper tool into the machine (press).
- Slide the lower tool into the base.

2

- Place correctly the PCB on the lower tool.
- Introduce the press-fit legs into the holes of the PCB.
- Push on top (100N mini per press-fit leg) until total insertion.

Note: the connector body must rest on the PCB.

1

- Place correctly the PCB and the connector on the lower tool.

2

- Place the upper tool at the back of the connector and place correctly the ejectors:
 - on the press-fit legs (if their length exceed the PCB thickness),
 - in the holes of the PCB (if not).
- Press the upper tool (100N mini per press-fit leg) to remove the connector until it slide down into the lower tool.

CAUTION :
A plated hole of the PCB can be used up to 3 times.

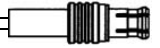

M 07

Part number	
R113 423 000 R113 423 810	R113 423 820

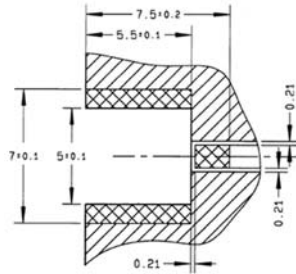

Part number		a	b	c
R113 424 000	R113 664 000	$\varnothing 1.7 \begin{smallmatrix} +0.1 \\ 0 \end{smallmatrix}$	1.2	0.21
R113 424 010	R113 664 100			
R113 424 020	R113 664 120			
R213 424 800	R213 664 800	$\varnothing 1.57 \begin{smallmatrix} +0.1 \\ 0 \end{smallmatrix}$	1	0.63

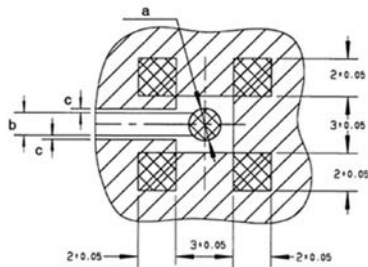

Part number	
R213 665 120	

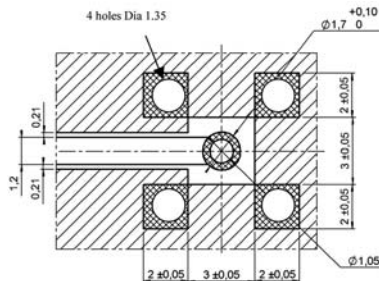

- Pattern
- Land for solder paste

COPLANAR LINE

Pattern and signal are on the same side.
 Thickness of PCB: .063 (1.6 mm).
 The material of PCB is the epoxy resin of glass fabrics bacs ($E_r = 4.8$).
 The solder resist should be printed except for the land pattern on the PCB.

VIDEO SHADOW

Part number	
R113 423 000 R113 423 810	R113 423 820

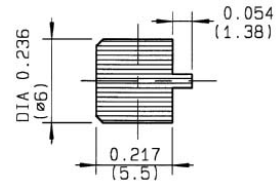

Part number	
R113 424 000 R113 424 010	R113 424 020 R213 424 800

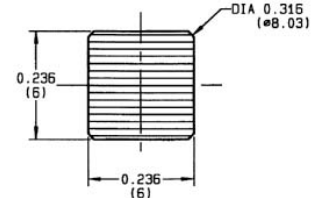

Part number	
R113 664 000 R113 664 100 R113 664 120	R213 664 800 R213 665 120

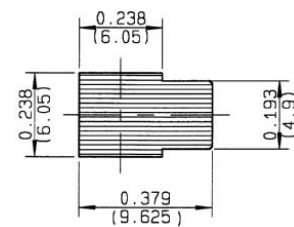

Vacuum nozzle dimensions

MCX 50Ω

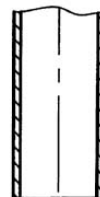

MCX 75Ω

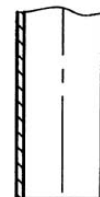

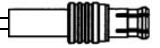

M 07 (flg)

SOLDER PROCEDURE

- 1 Deposition of solder paste "Sn Ag4 Cu0.5" on mounting zone by screen printing application. We recommend a low residue flux. We advise a thickness of 150 micromm (5.850 microinch). Verify that the edges of the zone are clean.
- 2 Placement of the receptacle on the mounting zone with an automatic machine of "pick and place" type.

- 3 Soldering by infra-red reflow.
- 4 Cleaning of printed circuit boards.
- 5 Checking of solder joints and position of the component by visual inspection.

TEMPERATURE PROFILE

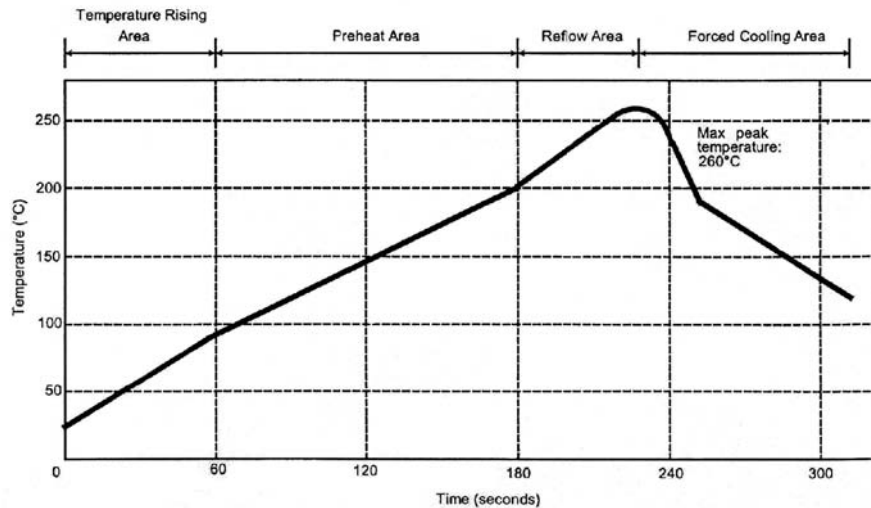

Parameter	Value	Unit
Temperature rising Area	1 - 4	°C/sec
Max Peak Temperature	260	°C
Max dwell time @260°C	10	sec
Min dwell time @235°C	20	sec
Max dwell time @235°C	60	sec
Temperature drop in cooling Area	-1 to -4	°C/sec
Max dwell time above 100°C	420	sec

NOTES

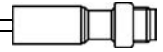

The new **MMBX™** connector series is particularly suitable for board to board connection in second and third generation telecommunication systems (GSM, PCS, WCDMA, UMTS...). **MMBX™** connectors allow a quick connection in a minimum space requirement. Frequency range is DC to 12.4 GHz. SMT connectors are totally compatible with pick and place machines.

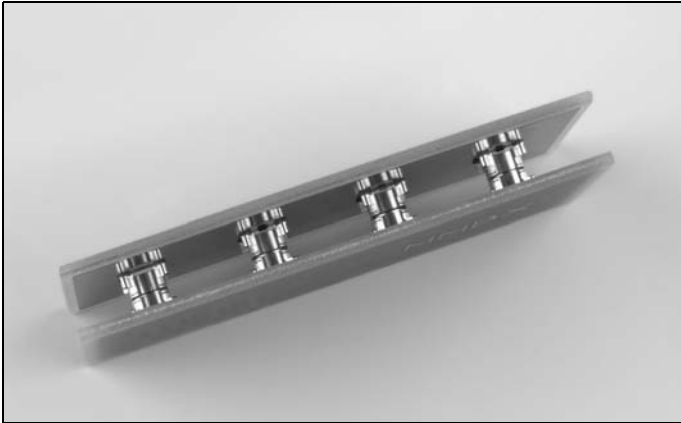

- **Space saving**

Its small space requirement is a main advantage for applications such as board to board connections as the height is only 7 mm.

- **Misalignment tolerance**

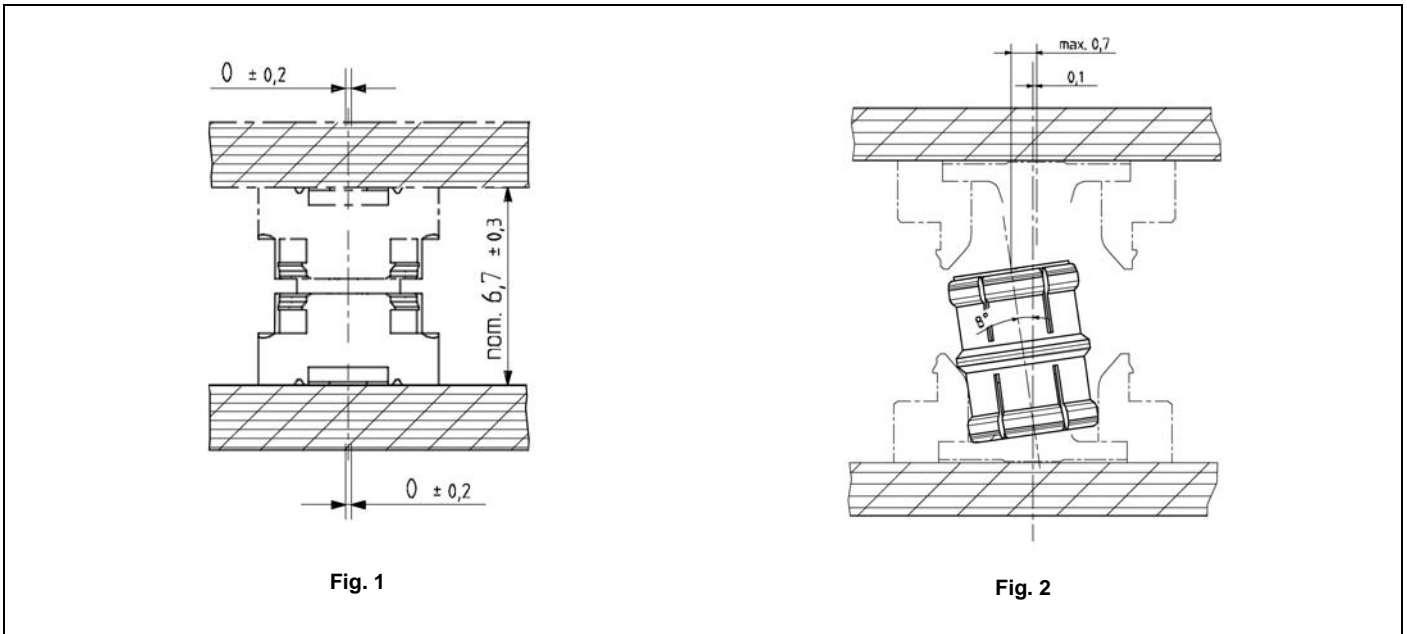

Fig. 1: Moreover, these connectors allow axial misalignment of 0.6 mm with a nominal value of 6.7 mm and radial misalignment of 0.4 mm easing connectors assembly.

The use of an in-series adapter permits these misalignments.

Fig. 2: The maximum tilt of the in-series adapter is 8° which is equivalent to 0.7 mm max between the centre line of the in-series adapter and the centre line of the PCB receptacle.

In this case, the allowed radial misalignment between the two centre lines of connectors is 0.1 mm and the chamfer still guarantee the connection.

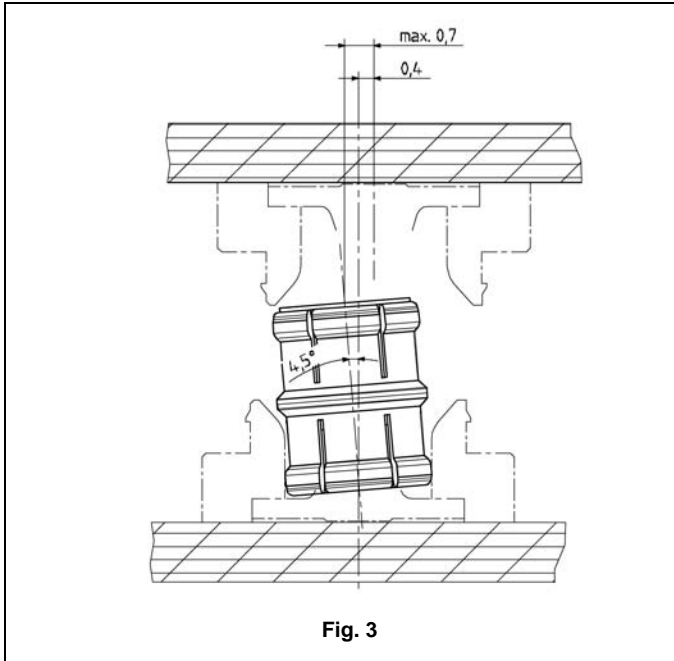
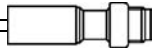
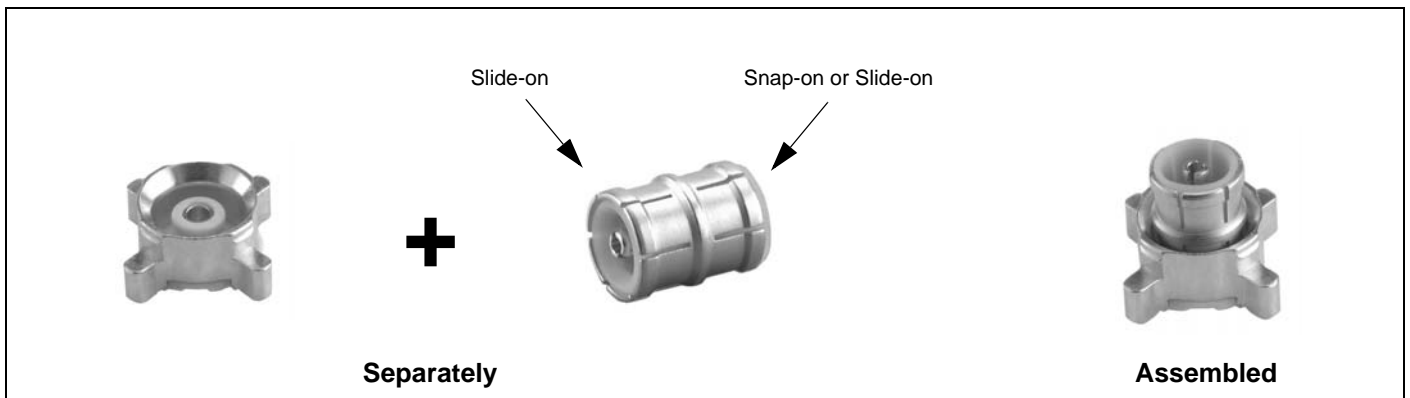

Fig. 3: When radial misalignment is at its maximum (0.4 mm), the allowed tilt is $\leq 4.5^\circ$.

The distance between the centre line of the in-series adapter and the centre line of the PCB receptacle is 0.7 mm max.

• Series Range

Receptacles and in-series adapters can be either sold separately or with the in-series adapter already inserted in the receptacle. In this case, assembly time will be reduced and you will be sure that the in-series adapter is properly inserted, as it has to be assembled perpendicularly to the receptacle.



Retention between receptacle and in-series adapter is ensured by the design of the adapter.

- Slide-on/Snap-on: for board to board application, all in-series adapters remain on the same side during disconnection.
- Slide-on/Slide-on

In addition of PCB connectors and in-series adapters, Radiall offers you a wide range of products like straight plugs, right angle plugs and between-series adapters.



50 Ω	DC - 12.4 GHz
-------------	----------------------

GENERAL

- Snap-on mating
- Microminiature coaxial connectors
- Robust
- Surface mount receptacles
- Fully compatible with automated pick and place machines

APPLICATIONS

- Board to board applications
- Base station
- High density packaging

PROFILE

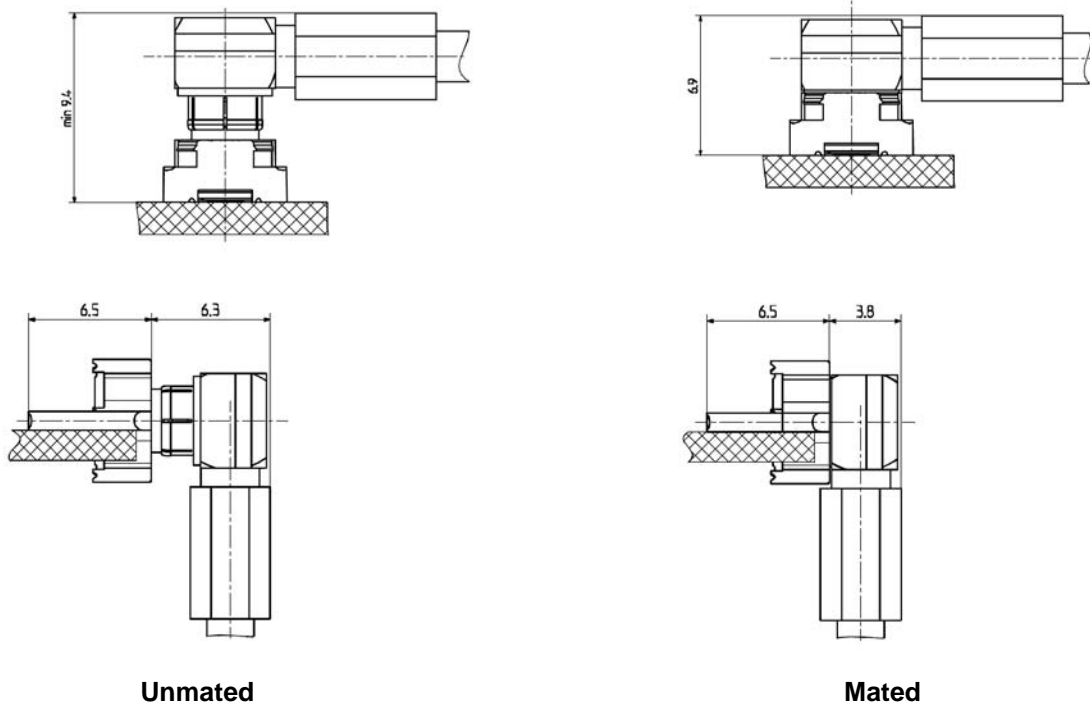

Unmated

Mated

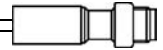

PCB connectors

PLUG

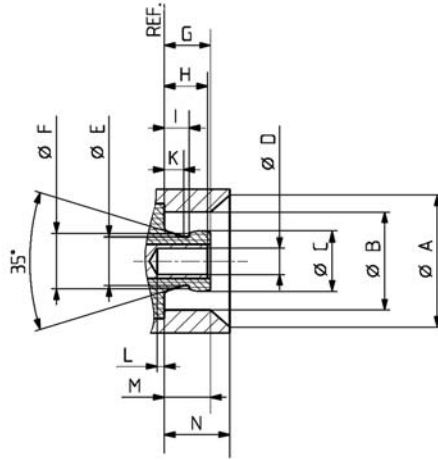

JACK

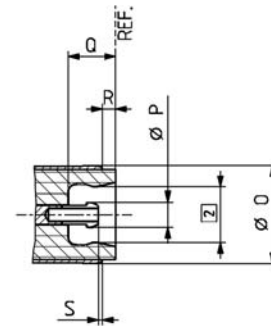

LETTER	mm		inch	
	min.	max.	min.	max.
A	5.00 nom.	5.00 nom.	.197 nom.	.197 nom.
B	3.68	3.71	.145	.146
C	2.25	2.30	.088	.090
D	0.98	1.01	.038	.040
E	1.85 nom.	1.85 nom.	.073 nom.	.073 nom.
F	2.10 nom.	2.10 nom.	.083 nom.	.083 nom.
G		1.80		.071
H	1.55	1.75	.061	.069
I	0.90		.035	

LETTER	mm		inch	
	min.	max.	min.	max.
K	0.75 nom.	0.75 nom.	.029 nom.	.029 nom.
L	0		0	
M	1.45		.057	
N	2.50 nom.	2.50 nom.	.098 nom.	.098 nom.
O	3.70 nom.	3.70 nom.	.146 nom.	.146 nom.
P	0.95 nom.	0.95 nom.	.037 nom.	.037 nom.
Q	1.85 nom.	1.85 nom.	.073 nom.	.073 nom.
R	0.50 nom.	0.50 nom.	.020 nom.	.020 nom.
S	0.10 nom.	0.10 nom.	.004 nom.	.004 nom.

In-series adapters

Slide-on

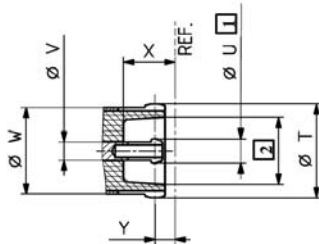

Snap-on

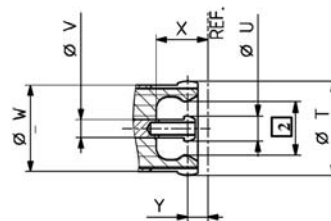

LETTER	mm	inch
T	3.70 nom.	.146 nom.
U	0.95 nom.	.037 nom.
V	0.70 nom.	.027 nom.

LETTER	mm	inch
W	3.65 nom.	.144 nom.
X	2.05 nom.	.080 nom.
Z	0.80 nom.	.031 nom.

- 1 Slotted and flared to meet electrical and mechanical requirements
- 2 Dimension to meet electrical and mechanical requirements

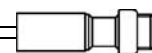

TEST / CHARACTERISTICS	CECC 22000	VALUES / REMARKS		
------------------------	------------	------------------	--	--

ELECTRICAL CHARACTERISTICS

Impedance		50 Ω		
Frequency range		DC - 12.4 GHz		
Typical V.S.W.R.		DC - 1 GHz	1 - 2.5 GHz	2.5 - 6 GHz
<ul style="list-style-type: none"> <i>Straight connectors</i> <ul style="list-style-type: none"> 2/50/S 2.6/50/S 2.6/50/D <i>Right angle connectors</i> <ul style="list-style-type: none"> 2/50/S 2.6/50/S 2.6/50/D 		1.05 1.05 1.05	1.06 1.06 1.06	1.10 1.10 1.10
Insulation resistance		> 1 GΩ		
Dielectric withstanding voltage	4.4.5			
<ul style="list-style-type: none"> (sea level) <ul style="list-style-type: none"> 2/50 2.6/50 		500 Vrms, 50 Hz 750 Vrms, 50 Hz		
Contact resistance				
<ul style="list-style-type: none"> centre contact outer contact 	4.4.2 4.4.3	≤ 5 mΩ ≤ 1 mΩ		

MECHANICAL CHARACTERISTICS

Mechanical endurance	4.7.1	100 matings		
Engagement and separation force	4.5.4	30 N max 8 - 30 N		
<ul style="list-style-type: none"> Engagement Separation 				
Contact captivation	4.5.2	≥ 10 N		
Cable retention force		58 N 110 N		
<ul style="list-style-type: none"> 2/50 2.6/50 				
Vibration	4.6.3 - IEC 68-2-6 Fc	MIL-STD-202, Method 204 D, condition A		

ENVIRONMENTAL CHARACTERISTICS

Temperature range		-55, +155°C		
Thermal shock	4.6.7 - IEC 68-2-14 Na	MIL-STD-202, Method 107G, condition B1		
Moisture resistance	4.6.6 - IEC 68-2-3 Ca	MIL-STD-202, Method 106F		
Corrosion	4.6.10 - IEC 68-2-11 Ka	MIL-STD-202, Method 101, condition B		
Vibration	4.6.3 - IEC 68-2-6 Fc	MIL-STD-202, Method 204D, condition A		

MATERIALS

Centre & outer contacts		Beryllium copper		
Bodies		Brass		
Ferrules		Copper		
Insulators		PTFE		

PLATINGS

Centre & outer contacts		Gold / NPGR*		
Bodies		NPGR*		
Ferrules		NPGR*		

* NPGR: Nickel Phosphorous Gold Radiall

Standard packaging = 100 pieces. For unit packaging add «W» after the P/N

All dimensions are given in mm

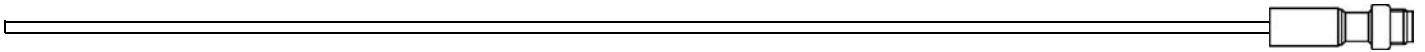

STRAIGHT PLUGS CRIMP TYPE FOR FLEXIBLE CABLES (male centre contact)

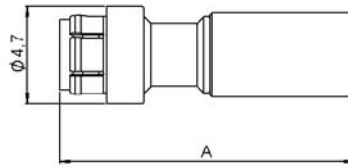

Cable group	Part Number	A	Captive centre contact	Assembly instructions
2 / 50 / S	R223 081 000	14.3	yes	M01
2.6 / 50 / S	R223 082 000	14.5		
2.6 / 50 / D	R223 083 000			

STRAIGHT PLUG SOLDER TYPE FOR SEMI-RIGID CABLES (male centre contact)

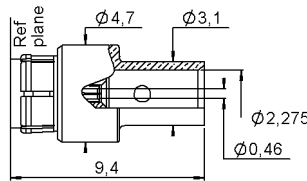

Cable group	Part Number	Captive centre contact	Assembly instructions
.085"	R223 062 000	yes	M02

RIGHT ANGLE PLUGS CRIMP TYPE FOR FLEXIBLE CABLES (male centre contact)

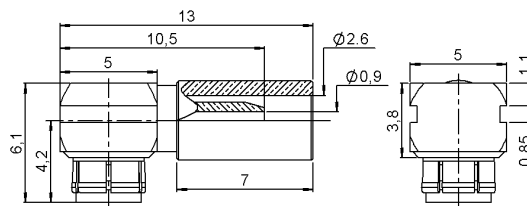

Cable group	Part Number	Captive centre contact	Assembly instructions
2 / 50 / S	R223 181 000	yes	M03
2.6 / 50 / S	R223 182 000		
2.6 / 50 / D	R223 183 000		

RIGHT ANGLE PLUG SOLDER TYPE FOR SEMI-RIGID CABLES (male centre contact)

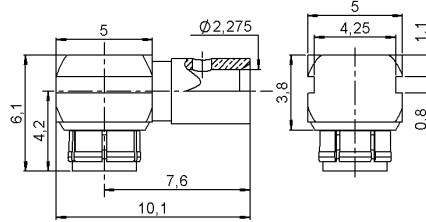

Cable group	Part Number	Captive centre contact	Assembly instructions
.085"	R223 162 000	yes	M04

STRAIGHT PCB RECEPTACLE (male centre contact)

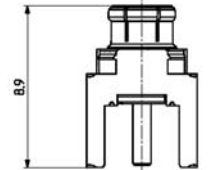
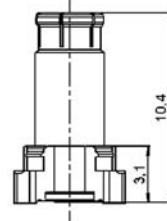
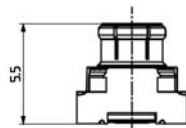
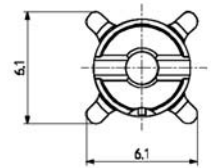
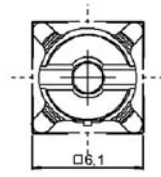
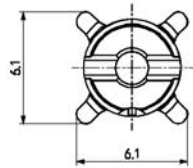
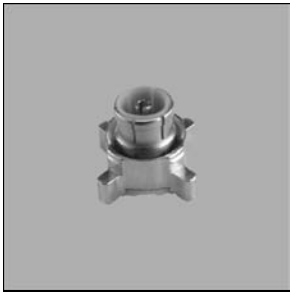

Fig. 1

Fig. 2

Fig. 3

Part Number	Fig.	Captive centre contact	PCB	Assembly instructions	Packaging	Note
R223 434 000	1	yes		M05	bulk 100 pcs	SMT
R223 434 000W	1				unit	
R223 434 020	2				bulk 100 pcs	
R223 434 800	1				tape & reel 750 pcs	
R223 435 000	3		P01		bulk 100 pcs	
R223 435 000W					unit	
R223 435 800					tape & reel 500 pcs	



EDGE CARD PCB RECEPTACLES (female centre contact)

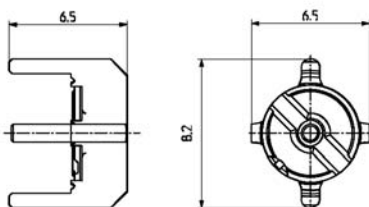

Fig. 1

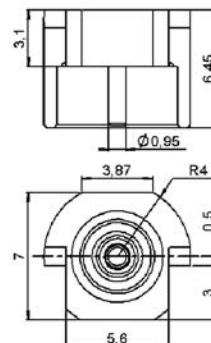

Fig. 2

Part Number	Fig.	Captive centre contact	Assembly instructions	Packaging	Note
R223 423 000	1	yes	M05	bulk 100 pcs	SMT edge card
R223 423 010	2				

STRAIGHT PCB RECEPTACLE (female centre contact)

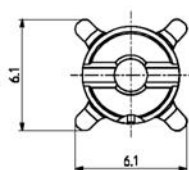

Fig. 1

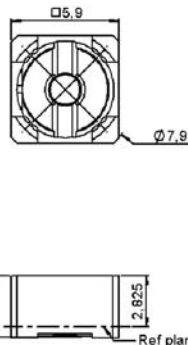

Fig. 2

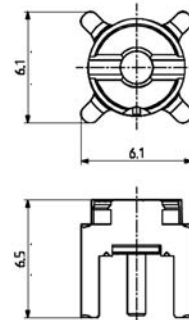
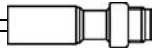
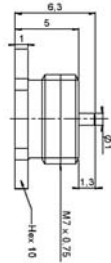

Fig. 3

Part Number	Fig.	Captive centre contact	PCB	Assembly instructions	Packaging	Note
R223 424 000	1	yes		M05	bulk 100 pcs	SMT
R223 424 000W					unit	
R223 424 200	2				bulk 100 pcs	
R223 424 800	1				tape & reel 750 pcs	
R223 425 000	3		P01		bulk 100 pcs	
R223 425 000W					unit	
R223 425 800		tape & reel 500 pcs				



SCREW-ON RECEPTACLE (female centre contact)



Part Number	Captive centre contact	Panel drilling
R223 555 000	yes	P03

IN SERIES ADAPTERS (male-male centre contact)

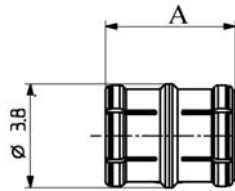
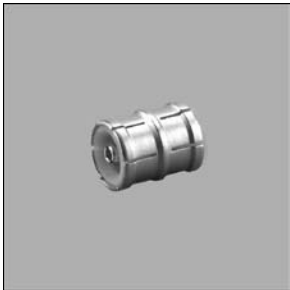

Part Number	Length A (mm)	Note	Nominal board to board
R223 703 000	4.8	interface: snap - slide	6.7
R223 703 020	9.7	interface: slide - slide	11.7

Other length can be designed upon request: 6.7 mm < board to board height < 20 mm

IN SERIES BULKHEAD ADAPTERS (male-male centre contact)

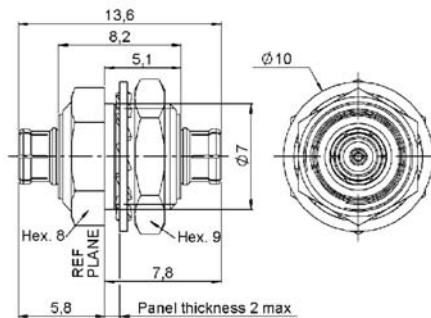

Part Number	Series	PCB
R223 720 020	MMBX male / MMBX male	P02

BETWEEN-SERIES ADAPTERS

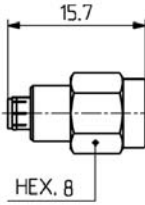

Fig. 1

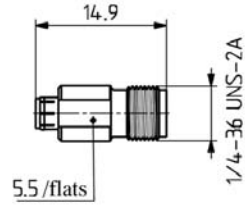

Fig. 2

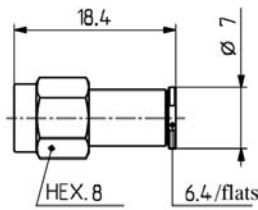

Fig. 3

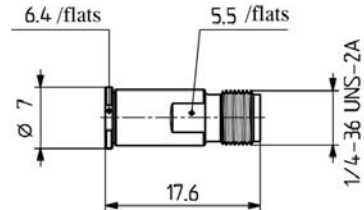
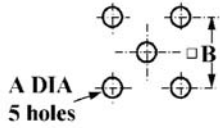

Fig. 4

Part Number	Fig.	Series	Packaging
R191 389 100	1	MMBX male / SMA male	unit
R191 389 200	2	MMBX male / SMA female	
R191 389 300	3	MMBX female / SMA male	
R191 389 400	4	MMBX female / SMA female	

PANEL DRILLING

P01



	mm		inch	
	maxi	mini	maxi	mini
A	1.4	1.2	.055	.047
B	5.16	5	.203	.197

P02



	mm		inch	
	maxi	mini	maxi	mini
A	7.27	7.13	.283	.281

P03



Threading	
ØA	M7 x 0.75

RECEPTACLES PACKAGING

The tape is delivered on reels of 330 mm diameter

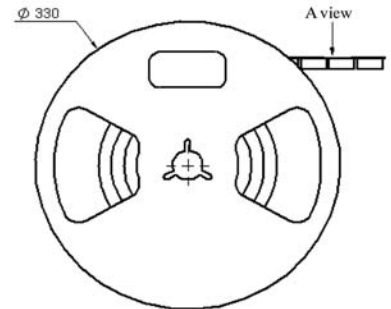

A view

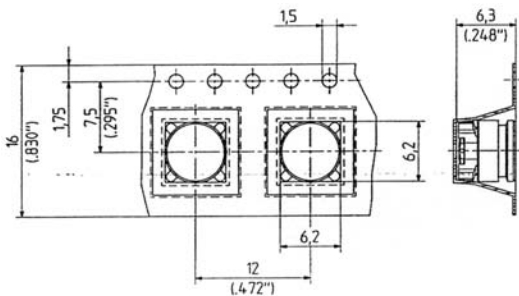

Part Number	Note
R223 424 800 R223 434 800	Including 750 receptacles

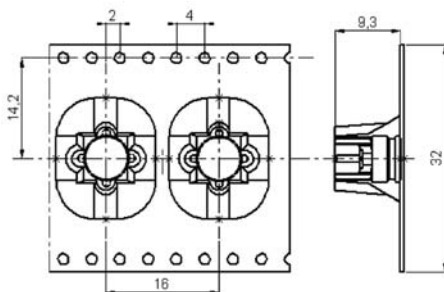

Part Number	Note
R223 425 800 R223 435 800	Including 500 receptacles

M 01

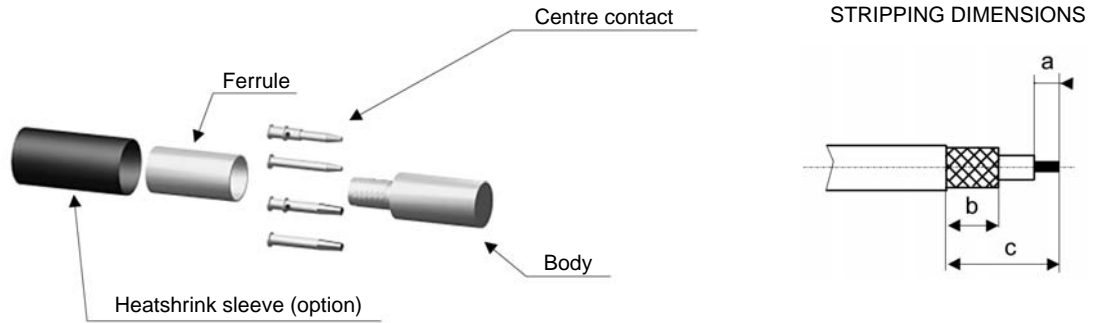

Part Number	Stripping length (mm)			Dies Dim. sq	Ferrule + centre contact MIL standard R282 293 000 (M22520/5-01) + dies
	a	b	c		
R223 081 000	1	5	7.5	0.54 - 3.3	R282 235 905
R223 082 000 R223 083 000	1.5	4.5	6.5	0.7 - 3.3	R282 235 906

- 1**
- Slide the heatshrink onto the cable (option).
 - Slide the ferrule onto the cable.
 - Strip the cable.

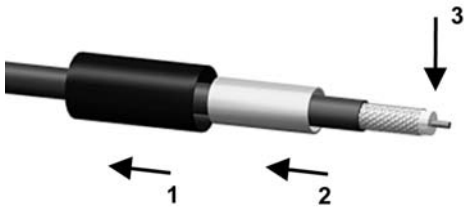

- 2**
- Slide the centre contact on until it bottoms against the cable dielectric.
 - Crimp the centre contact with crimping tool (see table).



- 3**
- Fan the braid.

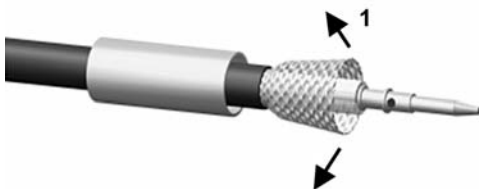

- 4**
- Slide the cable into the body until it bottoms against insulator.

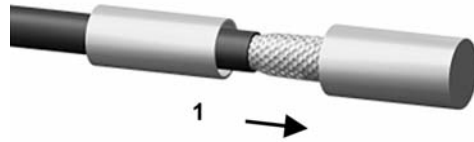

- 5**
- Slide the ferrule over the braid.
 - Crimp the ferrule with crimping tool (see table).

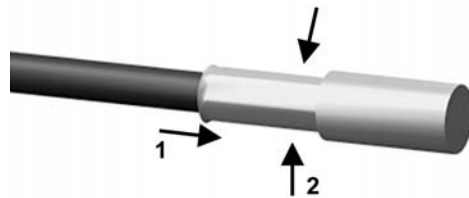

- 6**
- Cut the excess of braid if necessary.
 - Slide the sleeve over the ferrule and heatshrink it in place (option).

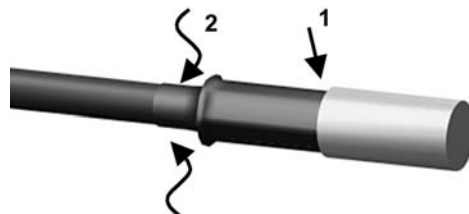

M 02

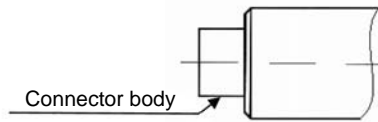

STRIPPING DIMENSIONS

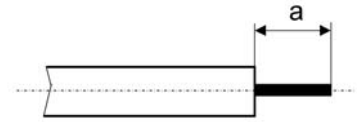

We recommend a thermal preconditioning cable.

Part Number	Stripping length (mm) a	Stripping tool	Pointer gauge	Soldering mounting
R223 062 000	1.5	R282 051 000	R282 062 000	R282 740 000

1

- Strip the cable.
- Stripping tool (see table).
- Positioner (see table).
- Trim cable centre conductor.
- Trimmer: (see table).

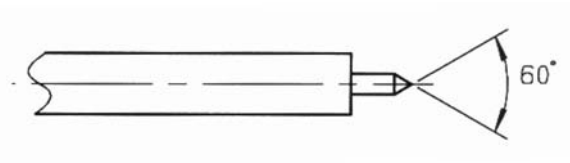

2

- Slide cable into connector body until it contacts the body shoulder.
- Place sub assembly into the assembly jig (see table).
- Insulator bottoms against the assembly jig.
- Solder body onto cable.
- Let the assembly cool down before removing it from the jig.
- Clean the solder area.

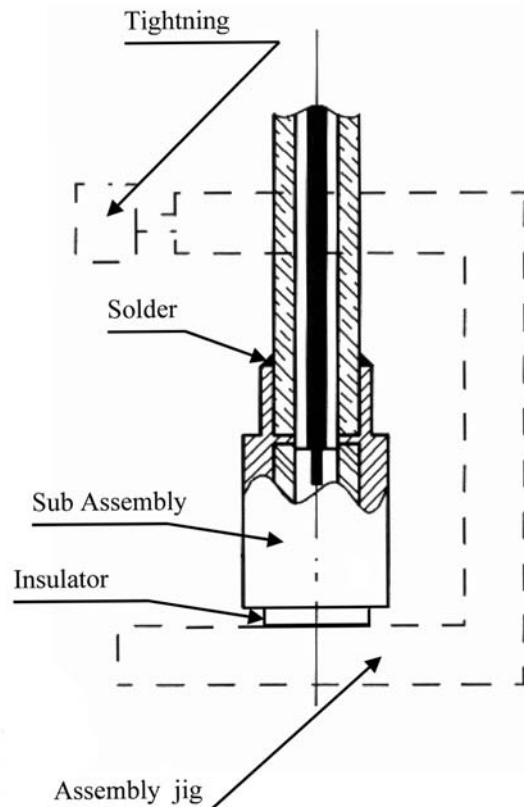

M 03

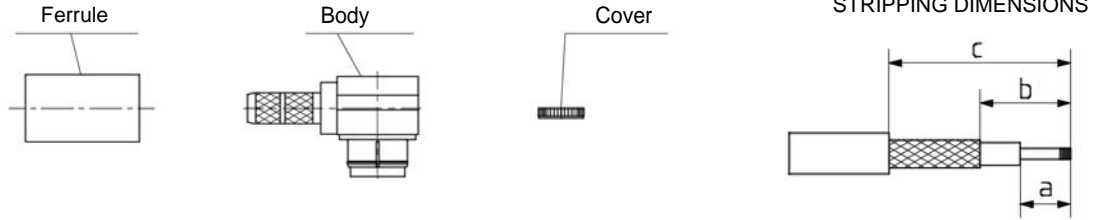

Part Number	Stripping length (mm)			Dies Dim. sq	Ferrule MIL standard R282 293 000 (M22520/5-01) + dies	Assembly tool
	a	b	c			
R223 181 000	1.5	4.5	9	3.3	R282 235 905	R282 868 000
R223 182 000 R223 183 000	2		9.5		R282 235 906	

1

- Slide the ferrule onto the cable.
 - Prepare cable according to diagram.
- Recommandation : to tin cable centre contact before assembling.
CAUTION : do not damage braid and inner conductor of cable.

3

- Slide ferrule over braid and crimp as close to connector body as possible.
- Solder inner conductor and place cover on rear opening body.

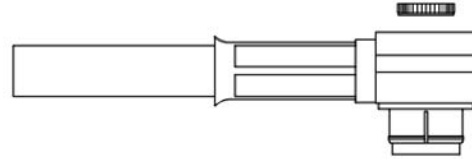

2

- Splay out braid and insert cable in connector body.
- Ensure that braid lies above the crimp neck.

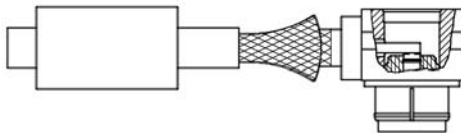

4

- Slide assembly tool in groove.
- Drive cover into rear opening of body by rotating the handle of the assembly-tool.

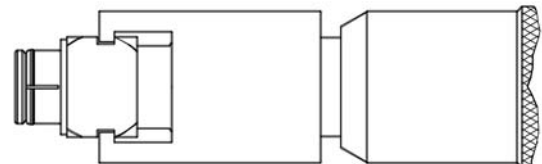

M 04

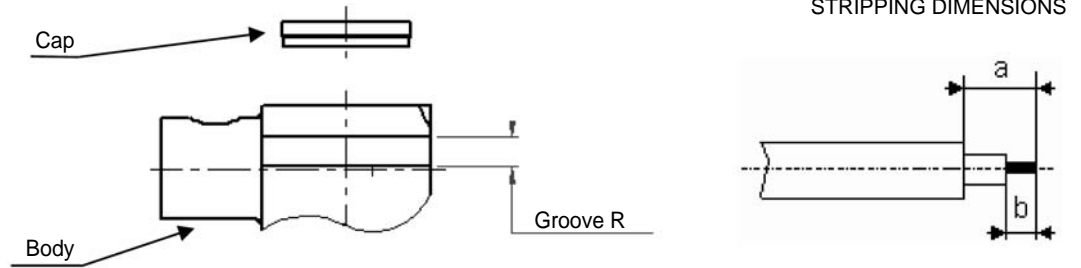

We recommend a thermal preconditioning cable.

Part Number	Stripping length (mm)		Extraction assembly tool
	a	b	
R223 162 000	2.6	1.4	R282 868 000

1

- Strip the cable.
- Tin cable inner conductor.

2

- Push the cable into the connector body until contact with it.
- Solder the cable on the connector body.
- Solder cable inner conductor into the centre contact.
- Clean soldering area.

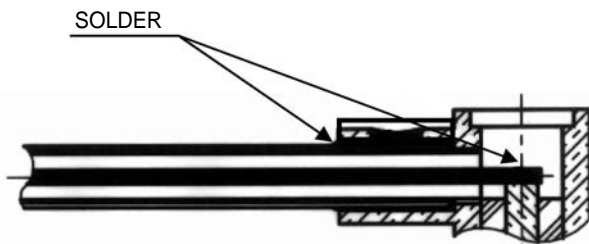

3

- Press fit the cap.

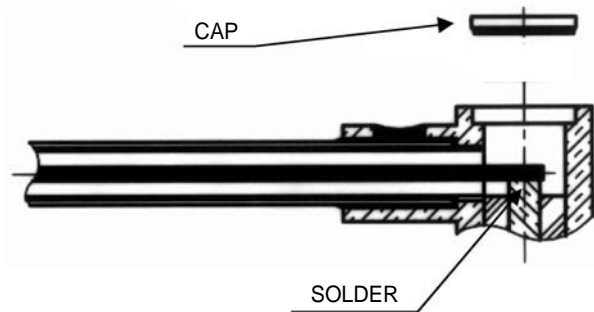

4

- Slide mounting tool onto the body grooves.
- Press fit the cap turning tool handle with adapted wrench 7mm (cap in the same face).

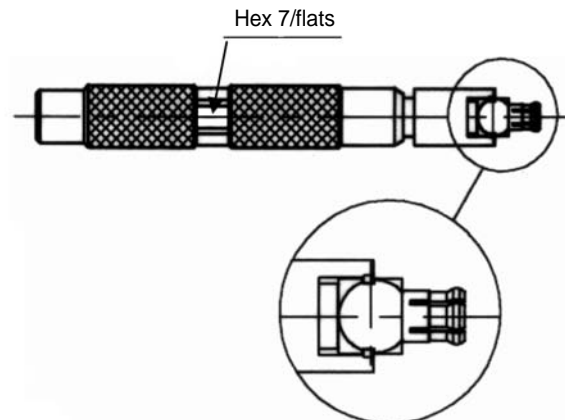

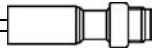

M 05

Part Number		
R223 423 000 R 223 423 010 R223 424 000 R223 424 000 W	R223 424 200 R223 424 800 R223 434 000	R223 434 000W R223 434 020 R223 434 800

- 1 - Deposit solder paste "Sn Ag4 Cu0.5" on mounting zone by screen printing application. We recommend a low residue flux. We advise a thickness of 150 microns (5.85 microinch). Verify that the edges of the zone are clean.
- 2 - Placement of the receptacle on the mounting zone with an automatic machine of "pick and place" type. A video camera is recommended for positioning of the component. Adhesive agents must not be used on the receptacle.
- 3 - This process of soldering has been tested with convection oven. Below, please find the typical profile to use.
- 4 - The cleaning of printed circuit boards is not obliged.
- 5 - Verification of solder joints and position of the component by visual inspection.

TEMPERATURE PROFILE

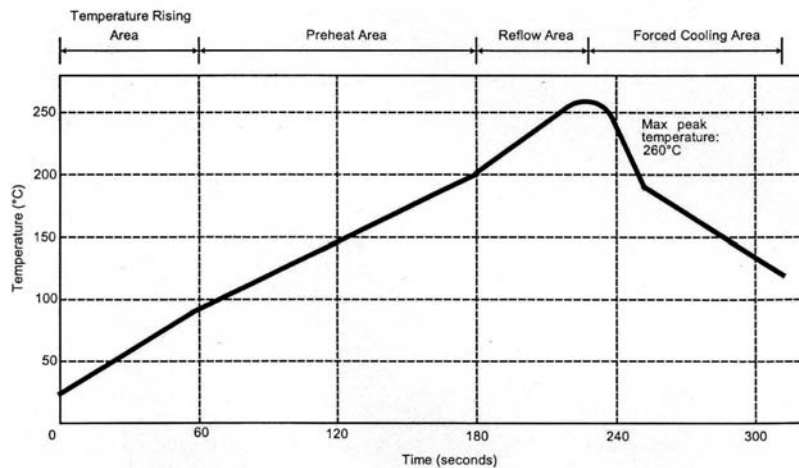

Parameter	Value	Unit
Temperature rising Area	1 - 4	°C/sec
Max Peak Temperature	260	°C
Max dwell time @260°C	10	sec
Min dwell time @235°C	20	sec
Max dwell time @235°C	60	sec
Temperature drop in cooling Area	- 1 to - 4	°C/sec
Max dwell time above 100°C	420	sec

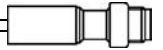

M 05(flq)

Part Number			
R223 424 000 R223 424 000 W	R223 424 200 R223 424 800	R223 434 000 R223 434 000W	R223 434 020 R223 434 800

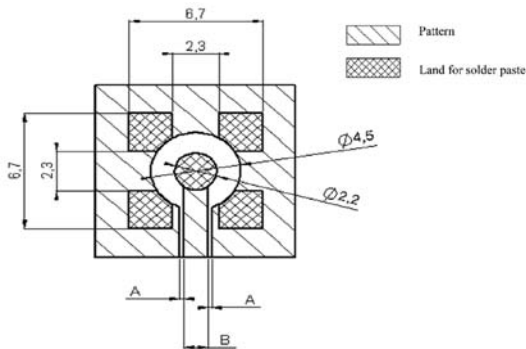

COPLANAR LINE

Pattern and signal are on the same side.
The material of PCB is epoxy resin (FR4) (Er = 4.6).
The solder resist should be printed except for the land pattern on the PCB.

APPLICATION 75 Ω
WITH B = 0.55 mm

PCB thickness (mm)	Coplanar ligne A (mm)
0.8	0.350
1.0	0.360
1.2	0.365
1.6	0.375

APPLICATION 50 Ω
WITH B = 1.2 mm

PCB thickness (mm)	Coplanar ligne A (mm)
0.8	0.190
1.0	0.200
1.2	0.205
1.6	0.210

Part Number	
R223 424 000 R223 424 000 W R223 424 800	R223 434 000 R223 434 000W R223 434 800

Part Number
R223 424 200

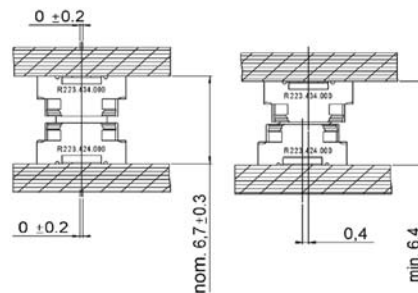
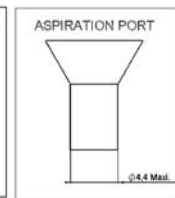
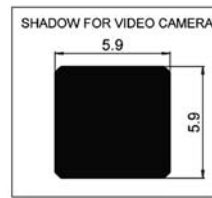
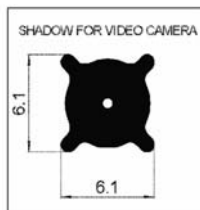

NOTES
